

4.5 Zimmer Wohnung 1:100 0 1 2 3
1.Obergeschoss

Nettowohnfläche 98.8m²
Loggia 20.2m²
Kellerraum UG 9.2m²

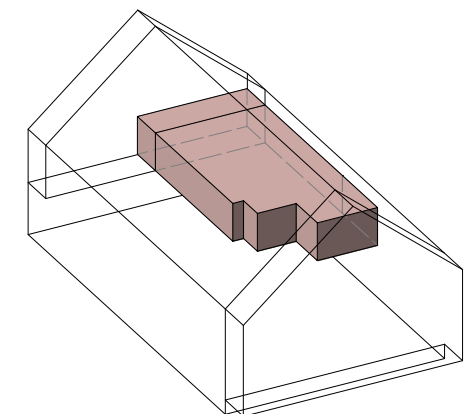

Übersicht Überbauung 1:1000



Übersicht Haus 51